

Linear

# TIMI Cove R030 Fixture Guide

# KKDÖ

Indoor | Surface | Output up to 2671lm/m (814lm/ft)



## Key applications

- ✓ Architectural detail
- ✓ Cove lighting
- ✓ Direct lighting
- ✓ Flood lighting
- ✓ Indirect lighting
- ✓ Interior
- ✓ Retail display
- ✓ Wall grazing
- ✓ Wall mounting

## Key features

- ✓ Adjustable
- ✓ Custom lengths
- ✓ Constant Voltage (CV)
- ✓ Diffusion: spoting
- ✓ Extensive CCT range
- ✓ High lumen efficacy
- ✓ IP40 dry area
- ✓ Lens options

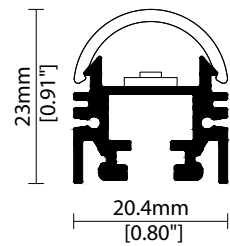

## MOUNTING METHODS



KKCP-11 Concealed clip



KKBK-25 Adjustable bracket

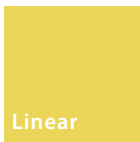

# TIMI Cove R030

## Specification sheet



<b>Dimensions</b>	H23/W20.4/L96-2013mm (H0.91/W0.8/L3.78-79.25in) (excluding brackets)
<b>PCB Cut-point</b>	41.7mm increment/2000mm max (1.64in increment/78.74in max)
<b>LED Pitch</b>	6.95mm-144LED/m (0.27in - 44LED/ft)
<b>Chip</b>	<b>s-line</b> <b>k-line</b>
<b>Cover/Optics</b>	Clear (110°) / Diffused (130°) / Semi-diffused (115°) / KKLN-02 lens (30°)
<b>CCT</b>	<b>s-line:</b> 1900K/2100K/2300K/2500K/2700K/3000K/3500K/4000K/5000K Single colours: Red/Green/Blue/Orange/Amber <b>k-line:</b> 1900K/2100K/2300K/2500K/2700K/3000K/3500K/4000K/5000K
<b>LED binning</b>	<b>s-line:</b> 2-step MacAdam ellipse <b>k-line:</b> 3-step MacAdam ellipse
<b>CRI</b>	≥92
<b>Lifetime</b>	50,000 hours @ 25°C (50,000 hours @ 77°F)
<b>Operating temp</b>	T <sub>a</sub> = -25°C to 50°C (T <sub>c</sub> max = 64.7°C) T <sub>a</sub> = -13 to 122°F (T <sub>c</sub> max = 148°F)
<b>IP Rating</b>	IP40
<b>Finish</b>	Silver anodised
<b>Mounting</b>	Surface mounting via clips or brackets
<b>Power feed</b>	Sheathed hardwire tails or male/female connectors
<b>Control</b>	0-10V/1-10V/DMX/DALI



### LED Grading Key

#### Exclusive Grade

**s-line\***  
2-step CCT range

\*KKDC tuned  
CCT range

#### Base Grade

**k-line**  
3-step commercial range  
Energy Star CCTs

<b>Power consumption</b>	<b>Supply voltage</b>	<b>Supply current</b>
30W/m (9.14W/ft)	24V DC	1.25A/m (0.381A/ft)

### Performance Data (3000K)

	R1	R2	R3	R4	R5	R6	R7	R8	R9	R10	R11	R12	R13	R14
<b>k-line</b>	92	96	97	90	91	93	92	82	60	89	90	74	93	98

	Clear Cover	Diffused Cover	Semi-diffused	30° (KKLN-02)	CRI	R9	Rf	Rg
<b>s-line</b>	2671lm/m (814lm/ft) 89lm/W	1685lm/m (514lm/ft) 56lm/W	2544lm/m (775lm/ft) 85lm/W	2512lm/m (766lm/ft) 84lm/W	93	61	-	-
<b>k-line</b>	2520lm/m (768lm/ft) 84 lm/W	1590m/m (485lm/ft) 53lm/W	2400lm/m (732lm/ft) 80lm/W	2370lm/m (722lm/ft) 79lm/W	92	60	-	-

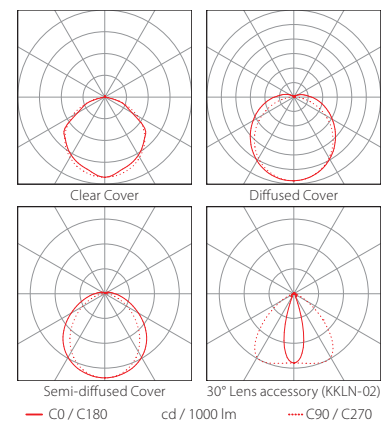
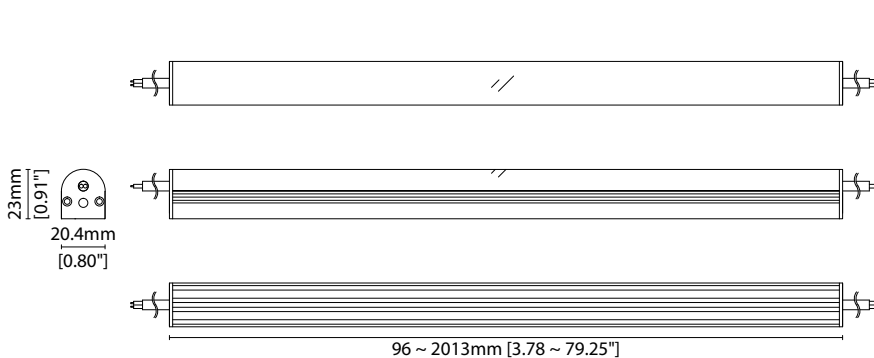

Data derived from independent UKAS / IESNA LM-79-08 accredited testing of production samples.

# TIMI Cove R030

## Code Table



### FIXTURE

Model	Finish	Cover/Lens <sup>1</sup>	Grade <sup>2</sup>	LED	Colour (CCT)	Length Availability <sup>3</sup>	IP	Cable Length	Power Feed <sup>4</sup>	Input												
TIMI Cove	PW	Silver anodised	SA	Clear	B	s	R030	R030	1900K	19	m	96-2013mm 41.7mm increments	IP40	40	300mm/ 11.81"	0300	Single ø4.3mm sheath tail	S00A	DC 24V	g		
										2100K											21	
										2300K											23	
										2500K											25	
										2700K											27	
										3000K											30	
										3500K											35	
										4000K											40	
										5000K											50	
										RED											RED	s only
										GREEN											GRN	
										BLUE											BLU	
										ORANGE											ORN	
AMBER	AMB																					

<sup>1</sup> Refer to **Cover Options** on **Options** pages

<sup>2</sup> Refer to **LED Grading Key** on **Specification sheet** page

<sup>3</sup> Refer to **Length Availability List** or enter total run length instead of length code

<sup>4</sup> Refer to **Power Feed Options** on **Options** pages

### Code Example:

PW	-	SA	-	C	-	s	-	R030	-	35	-	m	-	513	-	40	-	0300	-	D00A	-	g
TIMI Cove		Silver anodised		Diffused		s		R030		3500K		m		512.8mm		IP40		300mm/11.81"		Double ø4.3mm sheath tail		DC 24V

### ACCESSORIES

#### Mounting Accessories

KKCP-11	Concealed Clip (allow 3 per metre/40in)
KKBK-25	Adjustable bracket (allow 2 per metre/40in)

\* Refer to **Mounting accessories** on **Accessories** pages

#### Connection Accessories

KKCN-01	2 PIN male & female 50mm/1.97" pair
KKCN-03	2 PIN male & female 300mm/11.81" pair
KKCN-06	2 PIN 300mm/11.81" extension lead

\* Refer to **Power feed** on **Accessories** pages

#### PSU/Driver

0-10V/1-10V/DALI/DMX

\* Refer to **Driver/PSU Options** page for details or provide requirement and KKDC to offer the suitable option

### LED ENGINE VARIANTS (LED STRIP TYPE)

Colour	LED	Lumen/m	Lumen/ft	W/m	W/ft	Spec Doc	Length	Increment
Single CCT	R030	2671	814	30	9.14	TIMI Cove R030	96-2013mm (3.78-79.25in)	41.7 (1.64in)
	A040	4800	1463	40	12.19	TIMI Cove A040	90-1513mm (3.54-59.56in)	38.46 (1.51in)

\* Performance data: A/s/k-line, clear cover, 3000K

Linear

# TIMI Cove R030

## Length Availability List



Length Code		Fixture Length <sup>1</sup>		LED Strip <sup>2</sup>		End Cap Dimension <sup>3</sup>		Wattage (W)	Output (lm)
Metric	Imperial(US)	Metric	Imperial(US)	Metric	Imperial(US)	Metric	Imperial(US)		3000K (Test Data)
m0096	i0004	96mm	3.79in	83mm	3.28in	3mm	0.12in	2.50	210
m0138	i0005	138mm	5.43in	125mm	4.92in	3mm	0.12in	3.75	315
m0180	i0007	180mm	7.07in	167mm	6.56in	3mm	0.12in	5.00	420
m0221	i0009	221mm	8.71in	208mm	8.20in	3mm	0.12in	6.25	525
m0263	i0010	263mm	10.35in	250mm	9.84in	3mm	0.12in	7.50	630
m0305	i0012	305mm	11.99in	292mm	11.48in	3mm	0.12in	8.75	735
m0346	i0014	346mm	13.64in	333mm	13.12in	3mm	0.12in	10.00	840
m0388	i0015	388mm	15.28in	375mm	14.76in	3mm	0.12in	11.25	945
m0430	i0017	430mm	16.92in	417mm	16.40in	3mm	0.12in	12.50	1050
m0471	i0019	471mm	18.56in	458mm	18.04in	3mm	0.12in	13.75	1155
m0513	i0020	513mm	20.20in	500mm	19.69in	3mm	0.12in	15.00	1260
m0555	i0022	555mm	21.84in	542mm	21.33in	3mm	0.12in	16.25	1365
m0596	i0023	596mm	23.48in	583mm	22.97in	3mm	0.12in	17.50	1470
m0638	i0025	638mm	25.12in	625mm	24.61in	3mm	0.12in	18.75	1575
m0680	i0027	680mm	26.76in	667mm	26.25in	3mm	0.12in	20.00	1680
m0721	i0028	721mm	28.40in	708mm	27.89in	3mm	0.12in	21.25	1785
m0763	i0030	763mm	30.04in	750mm	29.53in	3mm	0.12in	22.50	1890
m0805	i0032	805mm	31.68in	792mm	31.17in	3mm	0.12in	23.75	1995
m0846	i0033	846mm	33.32in	833mm	32.81in	3mm	0.12in	25.00	2100
m0888	i0035	888mm	34.96in	875mm	34.45in	3mm	0.12in	26.25	2205
m0930	i0037	930mm	36.60in	917mm	36.09in	3mm	0.12in	27.50	2310
m0971	i0038	971mm	38.24in	958mm	37.73in	3mm	0.12in	28.75	2415
m1013	i0040	1013mm	39.88in	1000mm	39.37in	3mm	0.12in	30.00	2520
m1055	i0042	1055mm	41.52in	1042mm	41.01in	3mm	0.12in	31.25	2625
m1096	i0043	1096mm	43.16in	1083mm	42.65in	3mm	0.12in	32.50	2730
m1138	i0045	1138mm	44.80in	1125mm	44.29in	3mm	0.12in	33.75	2835
m1180	i0046	1180mm	46.44in	1167mm	45.93in	3mm	0.12in	35.00	2940
m1221	i0048	1221mm	48.08in	1208mm	47.57in	3mm	0.12in	36.25	3045
m1263	i0050	1263mm	49.72in	1250mm	49.21in	3mm	0.12in	37.50	3150
m1305	i0051	1305mm	51.36in	1292mm	50.85in	3mm	0.12in	38.75	3255
m1346	i0053	1346mm	53.01in	1333mm	52.49in	3mm	0.12in	40.00	3360
m1388	i0055	1388mm	54.65in	1375mm	54.13in	3mm	0.12in	41.25	3465
m1430	i0056	1430mm	56.29in	1417mm	55.77in	3mm	0.12in	42.50	3570
m1471	i0058	1471mm	57.93in	1458mm	57.41in	3mm	0.12in	43.75	3675
m1513	i0060	1513mm	59.57in	1500mm	59.06in	3mm	0.12in	45.00	3780
m1555	i0061	1555mm	61.21in	1542mm	60.70in	3mm	0.12in	46.25	3885
m1596	i0063	1596mm	62.85in	1583mm	62.34in	3mm	0.12in	47.50	3990
m1638	i0064	1638mm	64.49in	1625mm	63.98in	3mm	0.12in	48.75	4095
m1680	i0066	1680mm	66.13in	1667mm	65.62in	3mm	0.12in	50.00	4200
m1721	i0068	1721mm	67.77in	1708mm	67.26in	3mm	0.12in	51.25	4305
m1763	i0069	1763mm	69.41in	1750mm	68.90in	3mm	0.12in	52.50	4410
m1805	i0071	1805mm	71.05in	1792mm	70.54in	3mm	0.12in	53.75	4515
m1846	i0073	1846mm	72.69in	1833mm	72.18in	3mm	0.12in	55.00	4620

# TIMI Cove R030

## Length Availability List



Length Code		Fixture Length <sup>1</sup>		LED Strip <sup>2</sup>		End Cap Dimension <sup>3</sup>		Wattage (W)	Output (lm)
Metric	Imperial(US)	Metric	Imperial(US)	Metric	Imperial(US)	Metric	Imperial(US)		3000K (Test Data)
m1888	i0074	1888mm	74.33in	1875mm	73.82in	3mm	0.12in	56.25	4725
m1930	i0076	1930mm	75.97in	1917mm	75.46in	3mm	0.12in	57.50	4830
m1971	i0078	1971mm	77.61in	1958mm	77.10in	3mm	0.12in	58.75	4935
m2013	i0079	2013mm	79.25in	2000mm	78.74in	3mm	0.12in	60.00	5040

<sup>1</sup> Actual total overall length of light fixture (LED strip + end caps + void/wire hole)

<sup>2</sup> Actual length of PCB strip

<sup>3</sup> Actual length of 2x end caps

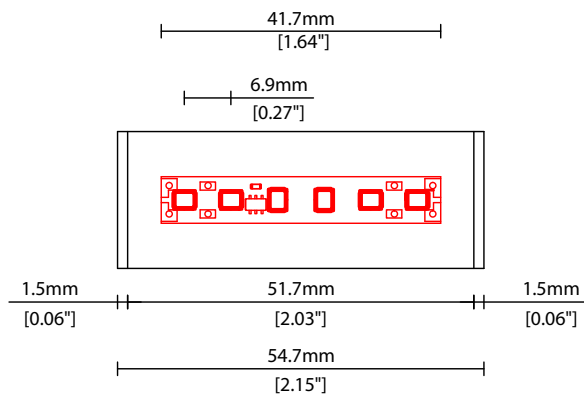

Linear

# TIMI Cove R030 Options

# KKDC

## COVER OPTIONS

\* Options are an integral part of the fixture ordering codes. Please refer to **Code Table** pages.

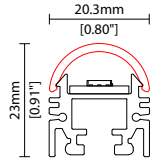

**B** Clear

W20.3/H23mm (W0.80/H0.91")

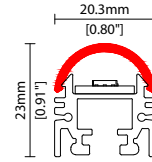

**C** Diffused

W20.3/H23mm (W0.80/H0.91")

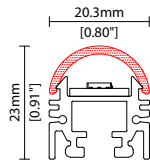

**D** Semi-diffused

W20.3/H23mm (W0.80/H0.91")

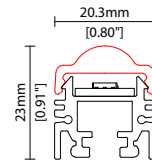

**H** 30° KKLN-02

W20.4/H23mm (W0.80/H0.91")

### POWER FEED OPTIONS

---

#### 0300 S00A 300mm (11.81") Single $\varnothing$ 4.3mm sheath tail

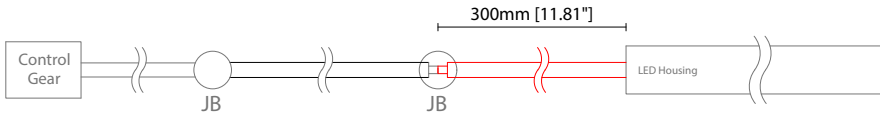

#### 0300 D00A 300mm (11.81") Double $\varnothing$ 4.3mm sheath tail

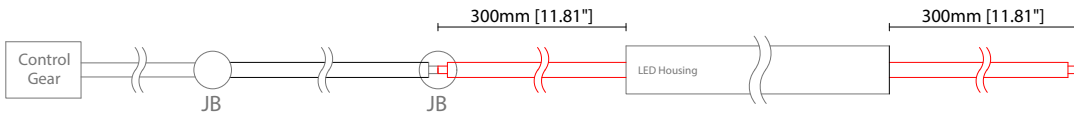

---

#### Key

Control Gear Power supply, sub-controllers & control systems  
JB Junction box / cable connection

---

## MOUNTING ACCESSORIES

Note: Accessories are to be ordered separately with corresponding code shown below.

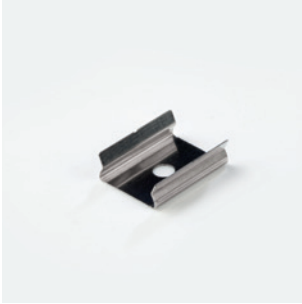

**KKCP-11**

Concealed clip  
(allow 3 per metre/40in)  
S/Steel finish  
L20/W20.3/H23.3mm  
(L0.79/W0.8/H0.92")

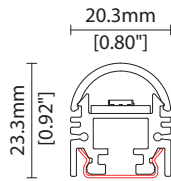

**KKBK-25**

Adjustable bracket  
(allow 2 per metre/40in)  
Anodised aluminium finish  
L30/W40/H30.8mm  
(L1.18/W1.57/H1.21")

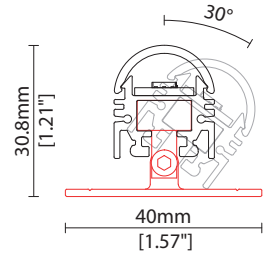

## POWER FEED

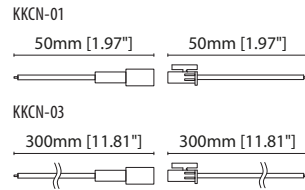
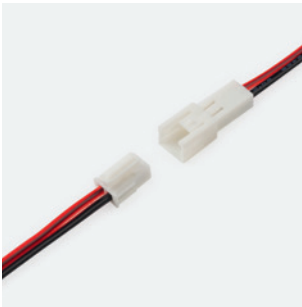

**KKCN-01** 50mm (1.97in) pair  
**KKCN-03** 300mm (11.81in) pair  
2 PIN male + female connector set



**KKCN-06**  
2 PIN 300mm (11.81in) extension lead



### KKDC CONTROL



IP20  
Plastic housing  
L170/W59/H29mm  
(L6.69/W2.32/H1.14in)

#### KKDM-06 1-10V

visDIM dimmable sub-controller  
(4 x 8A max @ 12-36V)



IP20  
Plastic housing  
L170/W53.4/H28mm  
(L6.69/W2.10/H1.10in)

#### KKSC-05 DMX

visDIM dimmable sub-controller  
(4 x 5A max @ 12-36V)



IP20  
Plastic housing  
L170/W59/H29mm  
(L6.69/W2.32/H1.14in)

#### KKDL-02 DALI

visDIM dimmable sub-controller  
(4 x 8A max @ 12-36V)



IP20  
Plastic housing  
L166/W53.4/H23mm  
(L6.54/W2.10/H0.91in)

#### KKDL-03 DALI

visDIM dimmable sub-controller  
(4 x 5A max @ 12-36V)

### AVAILABLE PSU OPTIONS

Control Mode	PSU (Order Code)	Input Voltage AC	Output Voltage DC	Rated Output Current	Rated Power	Dim %	IP Rating
Switched	CEN-60-24	90-295V	24V	2.5A	60W	-	IP67
	HLG-60H-24	90-305V	24V	2.5A	60W	-	IP67
	HLG-100H-24	90-305V	24V	4.0A	100W	-	IP67
	HLG-150H-24	90-305V	24V	6.3A	150W	-	IP67
	HLG-240H-24	90-305V	24V	10A	240W	-	IP67
0-10V (1-10V)	PWM-40-24	90-305V	24V	1.67A	40W	100-0.15 (100-10)	IP67
	PWM-60-24	90-305V	24V	2.5A	60W	100-0.15 (100-10)	IP67
	PWM-90-24	90-305V	24V	3.67A	90W	100-0.15 (100-10)	IP67
	PWM-120-24	90-305V	24V	5.0A	120W	100-0.15 (100-10)	IP67
DALI	LIN100A1	120-277V	24V	1A per channel	100W	100-0.1	IP66/IP40
DMX RGB	LIN100A1	120-277V	24V	1.33A per channel	100W	100-0.1	IP66/IP40
DMX RGBW	LIN100A1	120-277A	24V	1A per channel	100W	100-0.1	IP66/IP40

### Flicker Free Options - Combination of PSU+ sub-controller

Control Mode	PSU (Order Code)	Sub-controller (Order Code)	Input Voltage AC	Output Voltage DC	Rated Output Current	Rated Power	Dim %	IP Rating PSU/ Sub-controller
0-10V or 1-10V	CEN-60-24	KKDM-06	90-295V	24V	2.5A	60W	100-0.9	IP67/IP20
	HLG-60H-24	KKDM-06	90-295V	24V	2.5A	60W	100-0.9	IP67/IP20
	HLG-100H-24	KKDM-06	90-295V	24V	4.0A	100W	100-0.9	IP67/IP20
	HLG-150H-24	KKDM-06	90-295V	24V	6.3A	150W	100-0.9	IP67/IP20
	HLG-240H-24	KKDM-06	90-295V	24V	10.0A	240W	100-0.9	IP67/IP20
DALI	CEN-60-24	KKDL-02/03	90-295V	24V	2.5A	60W	100-0.1	IP67/IP20
	HLG-60H-24	KKDL-02/03	90-305V	24V	2.5A	60W	100-0.1	IP67/IP20
	HLG-100H-24	KKDL-02/03	90-305V	24V	4.0A	100W	100-0.1	IP67/IP20
	HLG-150H-24	KKDL-02/03	90-305V	24V	6.3A	150W	100-0.1	IP67/IP20
	HLG-240H-24	KKDL-02/03	90-305V	24V	10.0A	240W	100-0.1	IP67/IP20
DMX RGB	CEN-60-24	KKSC-05	90-295V	24V	2.5A	60W	100-0.9	IP67/IP20
	HLG-60H-24	KKSC-05	90-305V	24V	2.5A	60W	100-0.9	IP67/IP20
	HLG-100H-24	KKSC-05	90-305V	24V	4A	100W	100-0.9	IP67/IP20
	HLG-150H-24	KKSC-05	90-305V	24V	6.3A	150W	100-0.9	IP67/IP20
	HLG-240H-24	KKSC-05	90-305V	24V	10.0A	240W	100-0.9	IP67/IP20

<sup>1</sup> The items shown above cover the most frequently used specification but does not exhaust the possible options

<sup>2</sup> PSU and/or driver can be chosen from the table, or KKDC may recommend the best option upon receipt of the controls requirement and installation environment

<sup>3</sup> Electrical shop drawing will include detailed information of PSU and relevant control drivers

<sup>4</sup> Cut sheets are available on the controls section of [www.kkdc.lighting](http://www.kkdc.lighting) or upon request